

Lecture slides prepared for “Computer Organization and Architecture”, 9/e, by William Stallings, Chapter 3 “A Top Level View of Computer Function and Interconnection”.



## Chapter 3

### A Top-Level View of Computer Function and Interconnection

At a top level, a computer consists of CPU (central processing unit), memory, and I/O components, with one or more modules of each type. These components are interconnected in some fashion to achieve the basic function of the computer, which is to execute programs. Thus, at a top level, we can characterize a computer system by describing (1) the external behavior of each component, that is, the data and control signals that it exchanges with other components and (2) the interconnection structure and the controls required to manage the use of the interconnection structure.

This top-level view of structure and function is important because of its explanatory power in understanding the nature of a computer. Equally important is its use to understand the increasingly complex issues of performance evaluation. A grasp of the top-level structure and function offers insight into system bottlenecks, alternate pathways, the magnitude of system failures if a component fails, and the ease of adding performance enhancements. In many cases, requirements for greater system power and fail-safe capabilities are being met by changing the design rather than merely increasing the speed and reliability of individual components.

This chapter focuses on the basic structures used for computer component interconnection. As background, the chapter begins with a brief examination of the basic components and their interface requirements. Then a functional overview is provided. We are then prepared to examine the use of buses to interconnect system components.



# Computer Components

- Contemporary computer designs are based on concepts developed by John von Neumann at the Institute for Advanced Studies, Princeton
- Referred to as the *von Neumann architecture* and is based on three key concepts:
  - Data and instructions are stored in a single read-write memory
  - The contents of this memory are addressable by location, without regard to the type of data contained there
  - Execution occurs in a sequential fashion (unless explicitly modified) from one instruction to the next
- *Hardwired program*
  - The result of the process of connecting the various components in the desired configuration

As discussed in Chapter 2, virtually all contemporary computer designs are based on concepts developed by John von Neumann at the Institute for Advanced Studies, Princeton. Such a design is referred to as the *von Neumann architecture* and is based on three key concepts:

- Data and instructions are stored in a single read–write memory.
- The contents of this memory are addressable by location, without regard to the type of data contained there.
- Execution occurs in a sequential fashion (unless explicitly modified) from one instruction to the next.

The reasoning behind these concepts was discussed in Chapter 2 but is worth summarizing here. There is a small set of basic logic components that can be combined in various ways to store binary data and perform arithmetic and logical operations on that data. If there is a particular computation to be performed, a configuration of logic components designed specifically for that computation could be constructed. We can think of the process of connecting the various components in the desired configuration as a form of programming. The resulting “program” is in the form of hardware and is termed a *hardwired program*.

# Hardware and Software Approaches

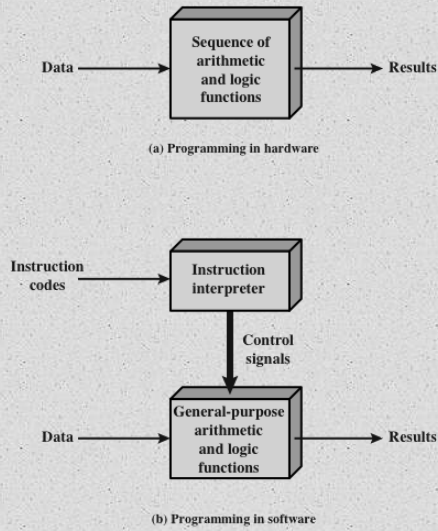
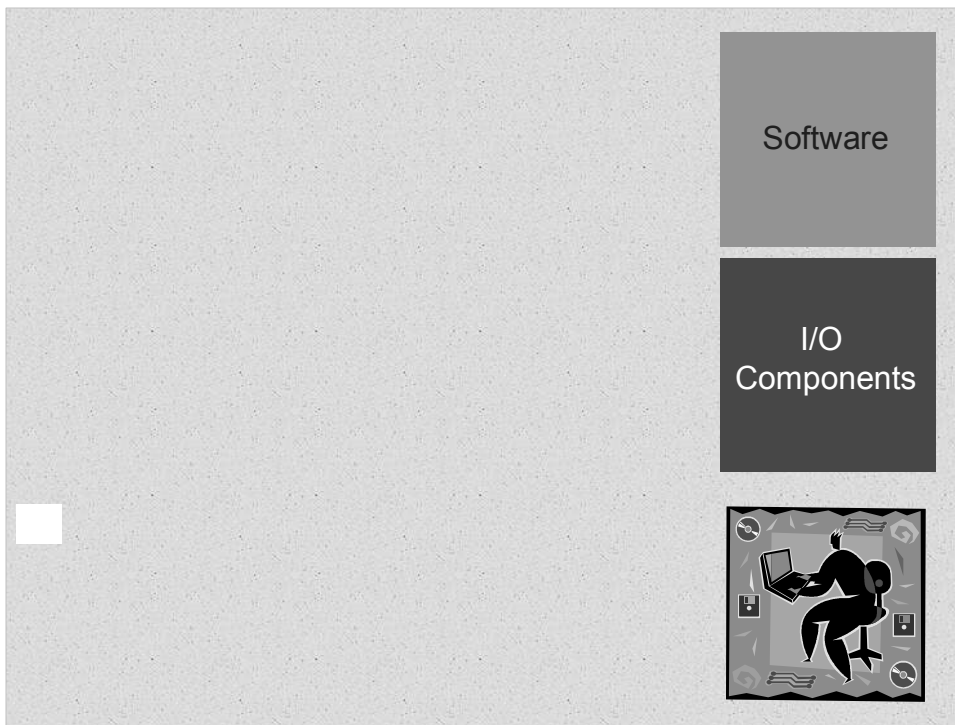

Figure 3.1 Hardware and Software Approaches

Now consider this alternative. Suppose we construct a general-purpose configuration of arithmetic and logic functions. This set of hardware will perform various functions on data depending on control signals applied to the hardware. In the original case of customized hardware, the system accepts data and produces results (Figure 3.1a). With general-purpose hardware, the system accepts data and control signals and produces results. Thus, instead of rewiring the hardware for each new program, the programmer merely needs to supply a new set of control signals. How shall control signals be supplied? The answer is simple but subtle. The entire program is actually a sequence of steps. At each step, some arithmetic or logical operation is performed on some data. For each step, a new set of control signals is needed. Let us provide a unique code for each possible set of control signals, and let us add to the general-purpose hardware a segment that can accept a code and generate control signals (Figure 3.1b).



Programming is now much easier. Instead of rewiring the hardware for each new program, all we need to do is provide a new sequence of codes. Each code is, in effect, an instruction, and part of the hardware interprets each instruction and generates control signals. To distinguish this new method of programming, a sequence of codes or instructions is called *software*.

Figure 3.1b indicates two major components of the system: an instruction interpreter and a module of general-purpose arithmetic and logic functions. These two constitute the CPU. Several other components are needed to yield a functioning computer. Data and instructions must be put into the system. For this we need some sort of input module. This module contains basic components for accepting data and instructions in some form and converting them into an internal form of signals usable by the system. A means of reporting results is needed, and this is in the form of an output module. Taken together, these are referred to as *I/O components*.



One more component is needed. An input device will bring instructions and data in sequentially. But a program is not invariably executed sequentially; it may jump around (e.g., the IAS jump instruction). Similarly, operations on data may require access to more than just one element at a time in a predetermined sequence. Thus, there must be a place to store temporarily both instructions and data. That module is called *memory, or main memory*, to distinguish it from external storage or peripheral devices. Von Neumann pointed out that the same memory could be used to store both instructions and data.

The CPU exchanges data with memory. For this purpose, it typically makes use of two internal (to the CPU) registers: a **memory address register (MAR)**, which specifies the address in memory for the next read or write, and a **memory buffer register (MBR)**, which contains the data to be written into memory or receives the data read from memory. Similarly, an I/O address register (IOAR) specifies a particular I/O device. An I/O buffer (IOBR) register is used for the exchange of data between an I/O module and the CPU.

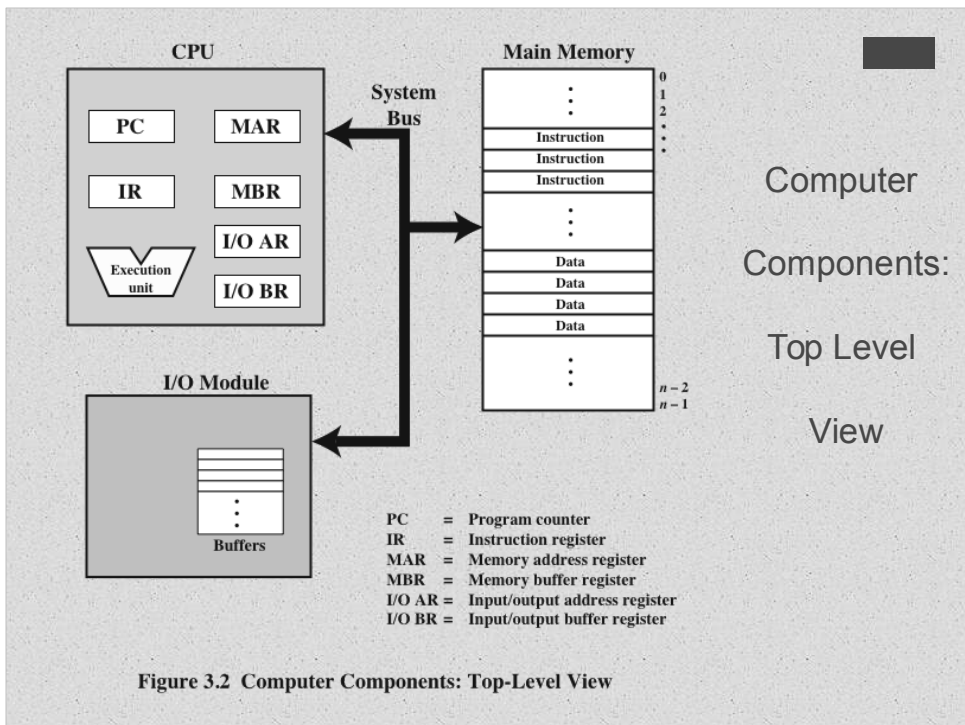
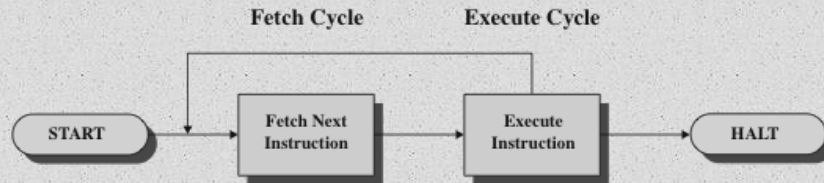

Figure 3.2 illustrates these top-level components and suggests the interactions among them.

A memory module consists of a set of locations, defined by sequentially numbered addresses. Each location contains a binary number that can be interpreted as either an instruction or data. An I/O module transfers data from external devices to CPU and memory, and vice versa. It contains internal buffers for temporarily holding these data until they can be sent on.

# + Basic Instruction Cycle



**Figure 3.3 Basic Instruction Cycle**

In its simplest form, instruction processing consists of two steps: The processor reads (*fetches*) instructions from memory one at a time and executes each instruction. Program execution consists of repeating the process of instruction fetch and instruction execution. The instruction execution may involve several operations and depends on the nature of the instruction.

The processing required for a single instruction is called an **instruction cycle**. Using the simplified two-step description given previously, the instruction cycle is depicted in Figure 3.3. The two steps are referred to as the **fetch cycle** and the **execute cycle**. Program execution halts only if the machine is turned off, some sort of unrecoverable error occurs, or a program instruction that halts the computer is encountered.





## Fetch Cycle

- At the beginning of each instruction cycle the processor fetches an instruction from memory
- The program counter (PC) holds the address of the instruction to be fetched next
- The processor increments the PC after each instruction fetch so that it will fetch the next instruction in sequence
- The fetched instruction is loaded into the instruction register (IR)
- The processor interprets the instruction and performs the required action



At the beginning of each instruction cycle, the processor fetches an instruction from memory. In a typical processor, a register called the program counter (PC) holds the address of the instruction to be fetched next. Unless told otherwise, the processor always increments the PC after each instruction fetch so that it will fetch the next instruction in sequence (i.e., the instruction located at the next higher memory address). So, for example, consider a computer in which each instruction occupies one 16-bit word of memory. Assume that the program counter is set to memory location 300, where the location address refers to a 16-bit word. The processor will next fetch the instruction at location 300. On succeeding instruction cycles, it will fetch instructions from locations 301, 302, 303, and so on. This sequence may be altered, as explained presently.

The fetched instruction is loaded into a register in the processor known as the instruction register (IR). The instruction contains bits that specify the action the processor is to take. The processor interprets the instruction and performs the required action.

# Action Categories

In general, these actions fall into four categories:

**Processor-memory:** Data may be transferred from processor to memory or from memory to processor.

• **Processor-I/O:** Data may be transferred to or from a peripheral device by transferring between the processor and an I/O module.

• **Data processing:** The processor may perform some arithmetic or logic operation on data.

• **Control: An instruction may specify that the sequence of execution be altered.**

For example, the processor may fetch an instruction from location 149, which specifies that the next instruction be from location 182. The processor will remember this fact by setting the program counter to 182. Thus, on the next fetch cycle, the instruction will be fetched from location 182 rather than 150.

An instruction's execution may involve a combination of these actions.

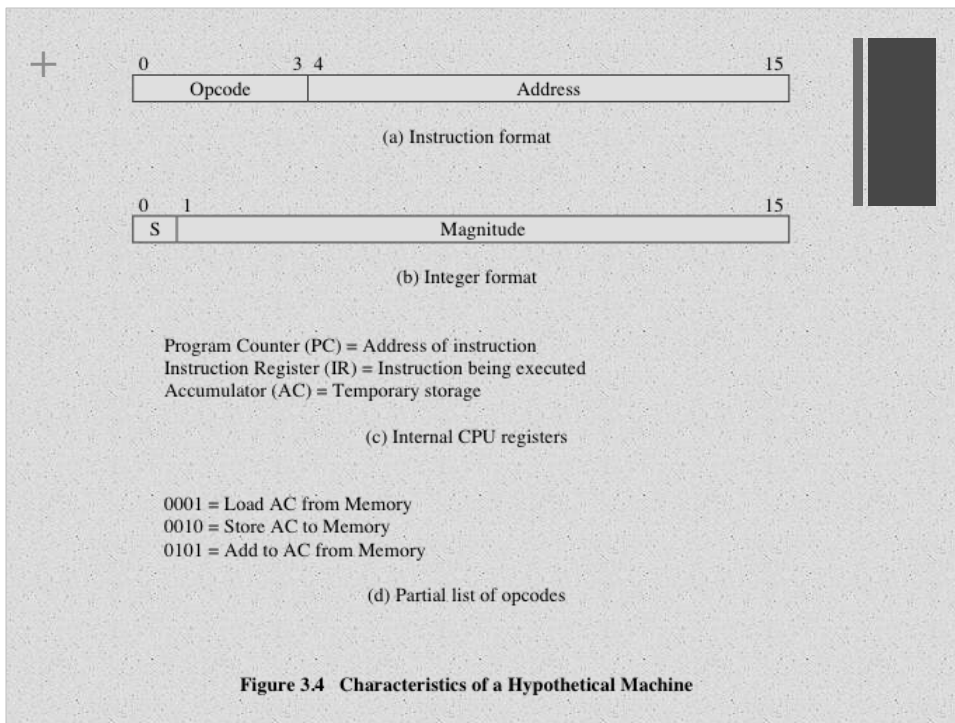

Consider a simple example using a hypothetical machine that includes the characteristics listed in Figure 3.4. The processor contains a single data register, called an accumulator (AC). Both instructions and data are 16 bits long. Thus, it is convenient to organize memory using 16-bit words. The instruction format provides 4 bits for the opcode, so that there can be as many as  $2^4 = 16$  different opcodes, and up to  $2^{12} = 4096$  (4K) words of memory can be directly addressed.

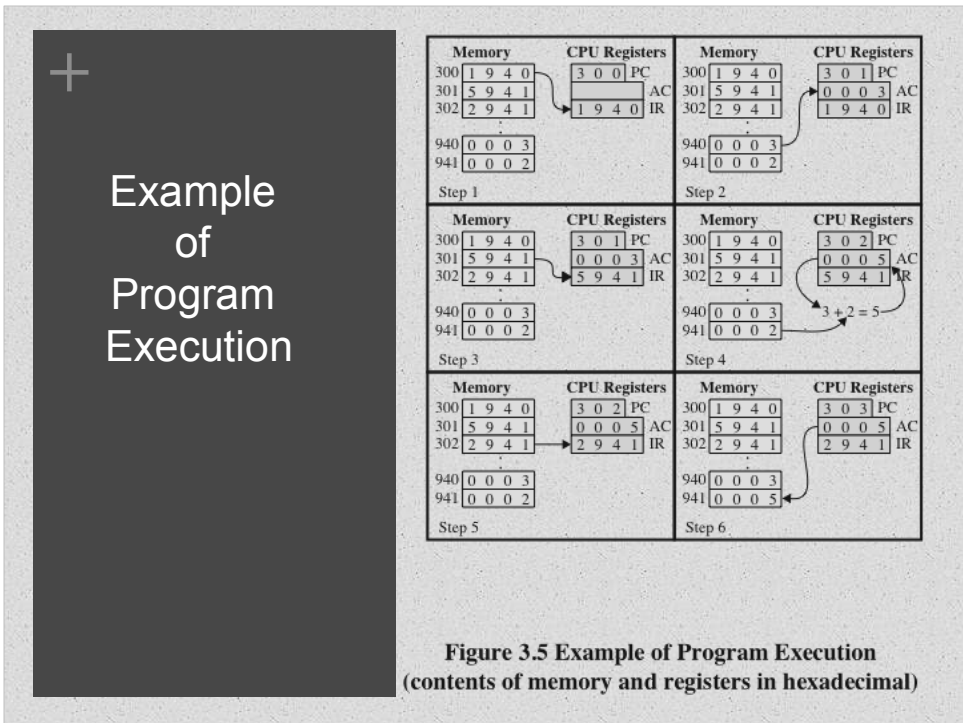
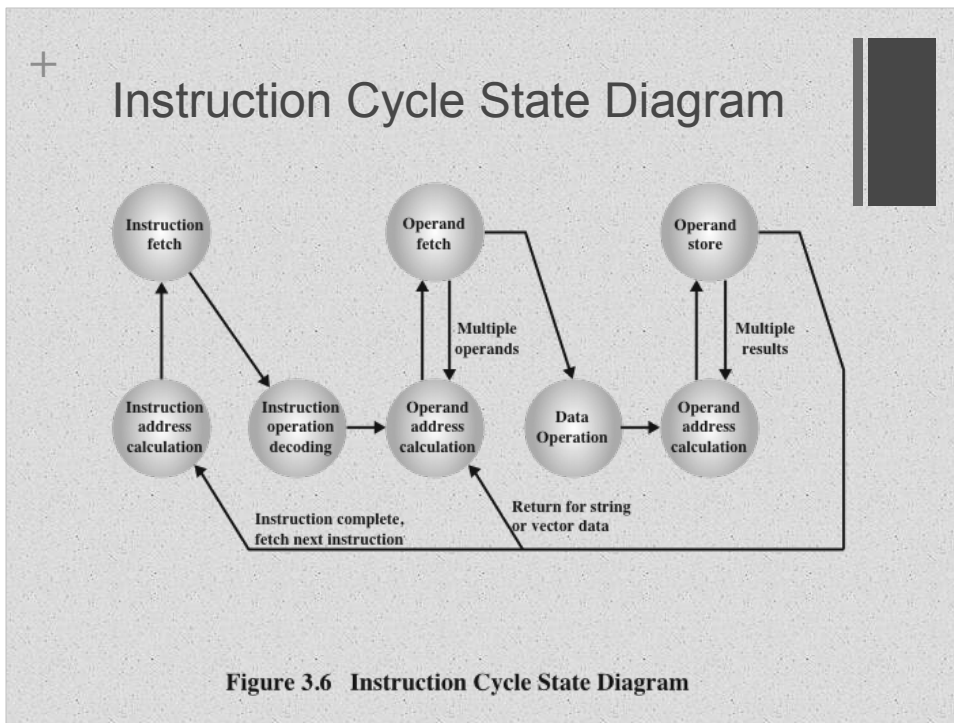

Figure 3.5 illustrates a partial program execution, showing the relevant portions of memory and processor registers. The program fragment shown adds the contents of the memory word at address 940 to the contents of the memory word at address 941 and stores the result in the latter location. Three instructions, which can be described as three fetch and three execute cycles, are required:

1. The PC contains 300, the address of the first instruction. This instruction (the value 1940 in hexadecimal) is loaded into the instruction register IR, and the PC is incremented. Note that this process involves the use of a memory address register and a memory buffer register. For simplicity, these intermediate registers are ignored.
2. The first 4 bits (first hexadecimal digit) in the IR indicate that the AC is to be loaded. The remaining 12 bits (three hexadecimal digits) specify the address (940) from which data are to be loaded.
3. The next instruction (5941) is fetched from location 301, and the PC is incremented.
4. The old contents of the AC and the contents of location 941 are added, and the result is stored in the AC.
5. The next instruction (2941) is fetched from location 302, and the PC is incremented.
6. The contents of the AC are stored in location 941.



The execution cycle for a particular instruction may involve more than one reference to memory. Also, instead of memory references, an instruction may specify an I/O operation. With these additional considerations in mind, Figure 3.6 provides a more detailed look at the basic instruction cycle of Figure 3.3. The figure is in the form of a state diagram.

For any given instruction cycle, some states may be null and others may be visited more than once. The states can be described as follows:

- **Instruction address calculation (iac):** Determine the address of the next instruction to be executed. Usually, this involves adding a fixed number to the address of the previous instruction. For example, if each instruction is 16 bits long and memory is organized into 16-bit words, then add 1 to the previous address. If, instead, memory is organized as individually addressable 8-bit bytes, then add 2 to the previous address.
- **Instruction fetch (if):** Read instruction from its memory location into the processor.
- **Instruction operation decoding (iod):** Analyze instruction to determine type of operation to be performed and operand(s) to be used.
- **Operand address calculation (oac):** If the operation involves reference to an operand in memory or available via I/O, then determine the address of the operand.

+

# Classes of Interrupts

|                         |  |
|-------------------------|--|
| <b>Program</b>          | Generated by some condition that occurs as a result of an instruction execution, such as arithmetic overflow, division by zero, attempt to execute an illegal machine instruction, or reference outside a user's allowed memory space. |
| <b>Timer</b>            | Generated by a timer within the processor. This allows the operating system to perform certain functions on a regular basis.   |
| <b>I/O</b>              | Generated by an I/O controller, to signal normal completion of an operation, request service from the processor, or to signal a variety of error conditions.   |
| <b>Hardware failure</b> | Generated by a failure such as power failure or memory parity error.   |

Virtually all computers provide a mechanism by which other modules (I/O, memory) may **interrupt** the normal processing of the processor. Table 3.1 lists the most common classes of interrupts. The specific nature of these interrupts is examined later in this book, especially in Chapters 7 and 14. However, we need to introduce the concept now to understand more clearly the nature of the instruction cycle and the implications of interrupts on the interconnection structure.

# Program Flow Control

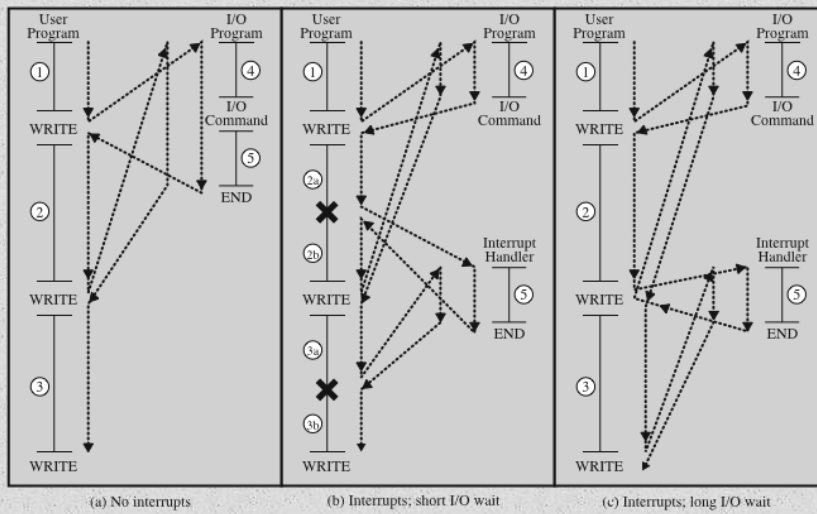

✕ = interrupt occurs during course of execution of user program

**Figure 3.7 Program Flow of Control Without and With Interrupts**

Interrupts are provided primarily as a way to improve processing efficiency.

For example, most external devices are much slower than the processor. Suppose that the processor is transferring data to a printer using the instruction cycle scheme of Figure 3.3. After each write operation, the processor must pause and remain idle until the printer catches up. The length of this pause may be on the order of many hundreds or even thousands of instruction cycles that do not involve memory. Clearly, this is a very wasteful use of the processor.

Figure 3.7a illustrates this state of affairs. The user program performs a series of WRITE calls interleaved with processing. Code segments 1, 2, and 3 refer to sequences of instructions that do not involve I/O. The WRITE calls are to an I/O program that is a system utility and that will perform the actual I/O operation. The I/O program consists of three sections:

- A sequence of instructions, labeled 4 in the figure, to prepare for the actual I/O operation. This may include copying the data to be output into a special buffer and preparing the parameters for a device command.
- The actual I/O command. Without the use of interrupts, once this command is issued, the program must wait for the I/O device to perform the requested function (or periodically poll the device). The program might wait by simply repeatedly performing a test operation to determine if the I/O operation is done.
- A sequence of instructions, labeled 5 in the figure, to complete the operation. This may include setting a flag indicating the success or failure of the operation.

# + Transfer of Control via Interrupts

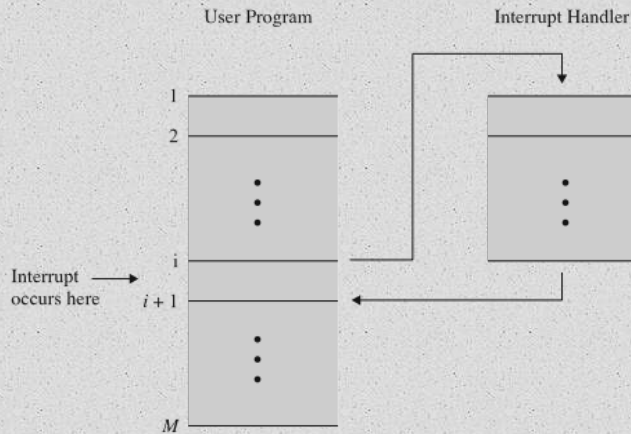

**Figure 3.8 Transfer of Control via Interrupts**

From the point of view of the user program, an interrupt is just that: an interruption of the normal sequence of execution. When the interrupt processing is completed, execution resumes (Figure 3.8). Thus, the user program does not have to contain any special code to accommodate interrupts; the processor and the operating system are responsible for suspending the user program and then resuming it at the same point.



+

## Instruction Cycle With Interrupts

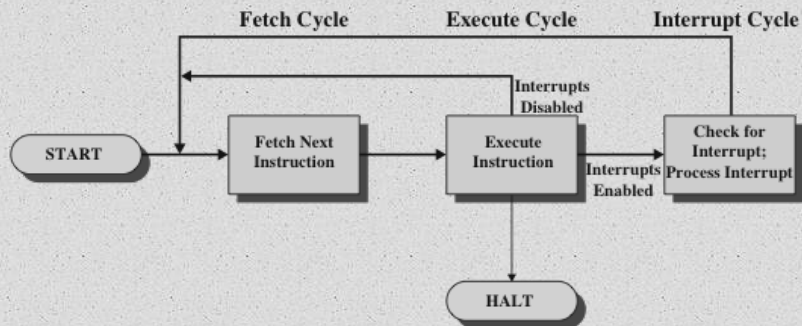

**Figure 3.9 Instruction Cycle with Interrupts**

To accommodate interrupts, an *interrupt cycle* is added to the instruction cycle, as shown in Figure 3.9. In the interrupt cycle, the processor checks to see if any interrupts have occurred, indicated by the presence of an interrupt signal. If no interrupts are pending, the processor proceeds to the fetch cycle and fetches the next instruction of the current program. If an interrupt is pending, the processor does the following:

- It suspends execution of the current program being executed and saves its context. This means saving the address of the next instruction to be executed (current contents of the program counter) and any other data relevant to the processor's current activity.
- It sets the program counter to the starting address of an *interrupt handler routine*.

The processor now proceeds to the fetch cycle and fetches the first instruction in the interrupt handler program, which will service the interrupt. The interrupt handler program is generally part of the operating system. Typically, this program determines the nature of the interrupt and performs whatever actions are needed. In the example we have been using, the handler determines which I/O module generated the interrupt and may branch to a program that will write more data out to that I/O module. When the interrupt handler routine is completed, the processor can resume execution of the user program at the point of interruption.

It is clear that there is some overhead involved in this process. Extra instructions must be executed (in the interrupt handler) to determine the nature of the interrupt and to decide on the appropriate action. Nevertheless, because of the relatively large amount of time that would be wasted by simply waiting on an I/O operation, the processor can be employed much more efficiently with the use of interrupts.

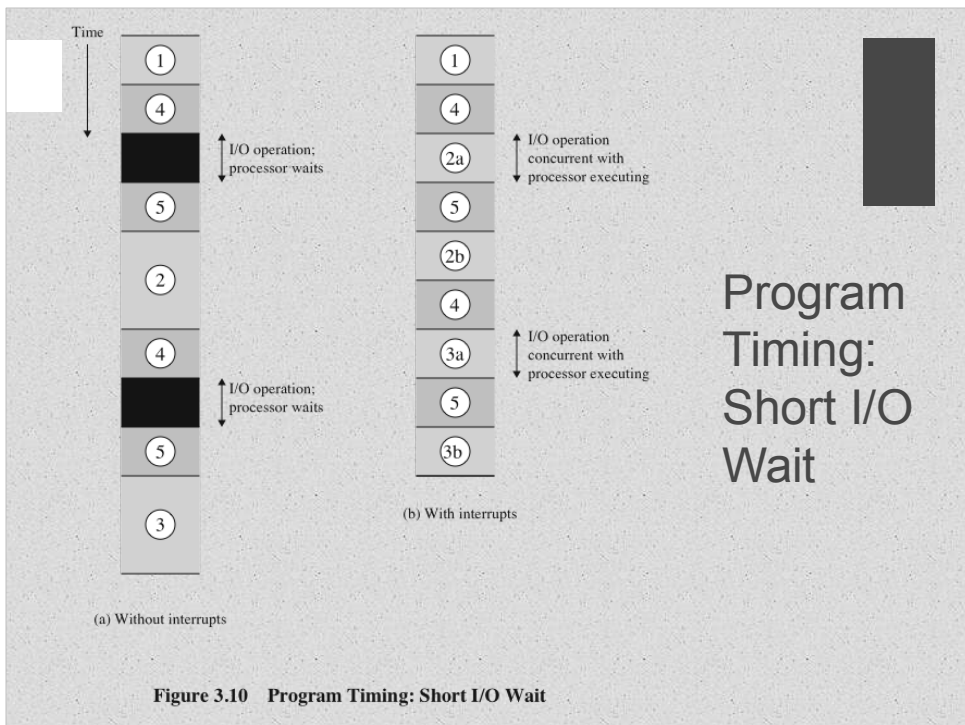

To appreciate the gain in efficiency, consider Figure 3.10, which is a timing diagram based on the flow of control in Figures 3.7a and 3.7b. In this figure, user program code segments are shaded green, and I/O program code segments are shaded gray. Figure 3.10a shows the case in which interrupts are not used. The processor must wait while an I/O operation is performed.

Figures 3.7b and 3.10b assume that the time required for the I/O operation is relatively short: less than the time to complete the execution of instructions between write operations in the user program. In this case, the segment of code labeled code segment 2 is interrupted. A portion of the code (2a) executes (while the I/O operation is performed) and then the interrupt occurs (upon the completion of the I/O operation). After the interrupt is serviced, execution resumes with the remainder of code segment 2 (2b).

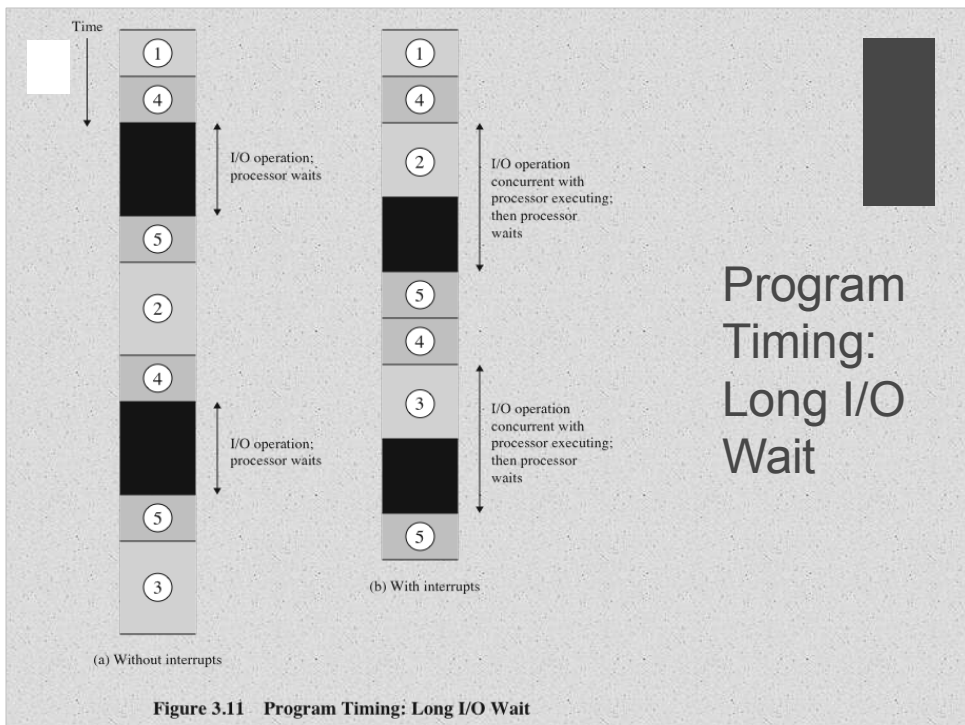

The more typical case, especially for a slow device such as a printer, is that the I/O operation will take much more time than executing a sequence of user instructions. Figure 3.7c indicates this state of affairs. In this case, the user program reaches the second WRITE call before the I/O operation spawned by the first call is complete. The result is that the user program is hung up at that point. When the preceding I/O operation is completed, this new WRITE call may be processed, and a new I/O operation may be started. Figure 3.11 shows the timing for this situation with and without the use of interrupts. We can see that there is still a gain in efficiency because part of the time during which the I/O operation is under way overlaps with the execution of user instructions.

# Instruction Cycle State Diagram With Interrupts

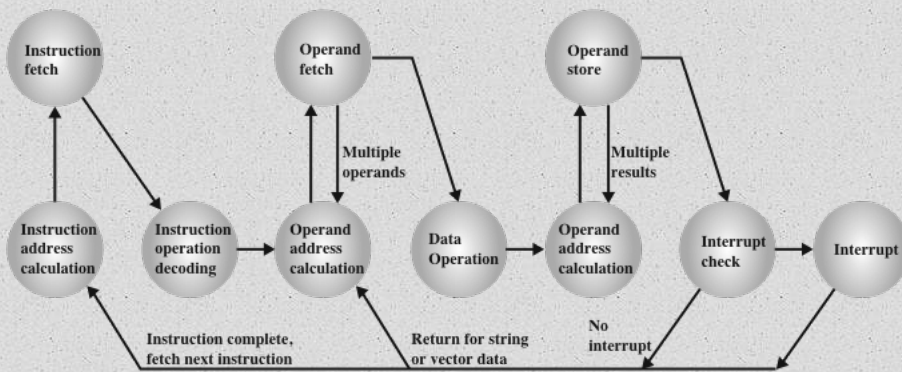

Figure 3.12 Instruction Cycle State Diagram, With Interrupts

Figure 3.12 shows a revised instruction cycle state diagram that includes interrupt cycle processing.

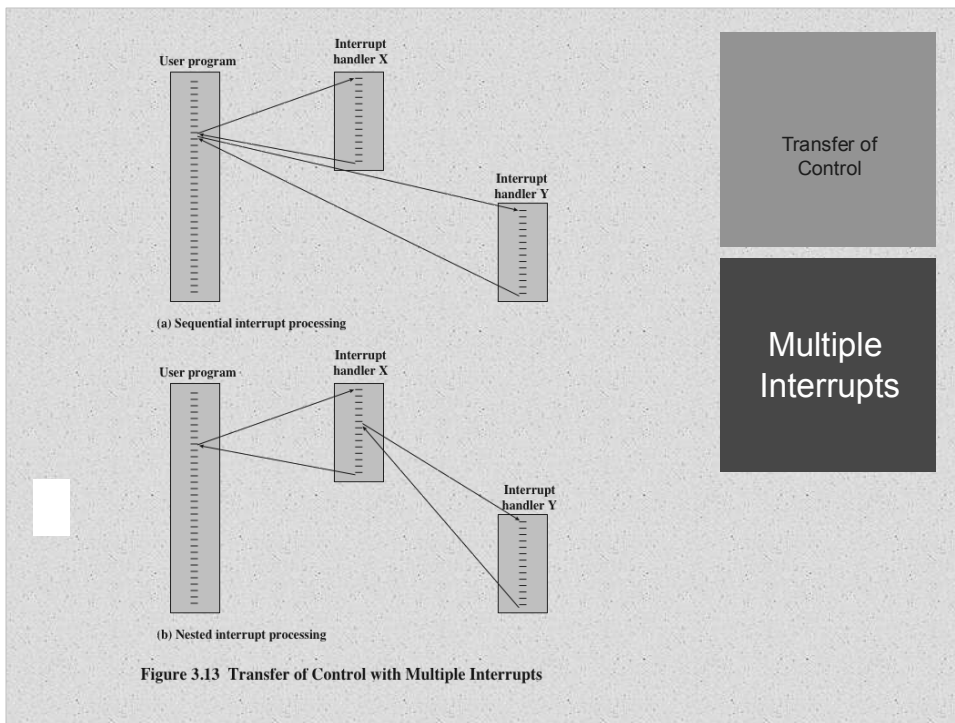

Figure 3.13 Transfer of Control with Multiple Interrupts

Two approaches can be taken to dealing with multiple interrupts. The first is to disable interrupts while an interrupt is being processed. A **disabled interrupt** simply means that the processor can and will ignore that interrupt request signal. If an interrupt occurs during this time, it generally remains pending and will be checked by the processor after the processor has enabled interrupts. Thus, when a user program is executing and an interrupt occurs, interrupts are disabled immediately. After the interrupt handler routine completes, interrupts are enabled before resuming the user program, and the processor checks to see if additional interrupts have occurred. This approach is nice and simple, as interrupts are handled in strict sequential order (Figure 3.13a).

The drawback to the preceding approach is that it does not take into account relative priority or time-critical needs. For example, when input arrives from the communications line, it may need to be absorbed rapidly to make room for more input. If the first batch of input has not been processed before the second batch arrives, data may be lost.

A second approach is to define priorities for interrupts and to allow an interrupt of higher priority to cause a lower-priority interrupt handler to be itself interrupted (Figure 3.13b).

## + Time Sequence of Multiple Interrupts

Ex  
am  
ple

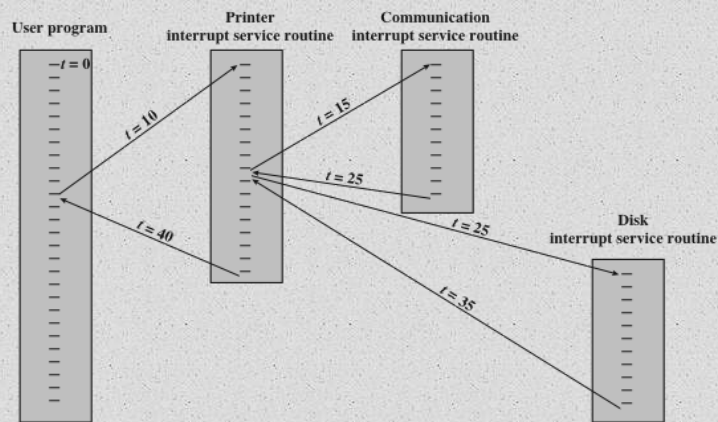

Figure 3.14 Example Time Sequence of Multiple Interrupts

As an example of this second approach, consider a

system with three I/O devices: a printer, a disk, and a communications line, with increasing priorities of 2, 4, and 5, respectively. Figure 3.14 illustrates a possible sequence. A user program begins at  $t = 0$ . At  $t = 10$ , a printer interrupt occurs; user information is placed on the system stack and execution continues at the printer **interrupt service routine (ISR)**. While this routine is still executing, at  $t = 15$ , a communications interrupt occurs. Because the communications line has higher priority than the printer, the interrupt is honored. The printer ISR is interrupted, its state is pushed onto the stack, and execution continues at the communications ISR. While this routine is executing, a disk interrupt occurs ( $t = 20$ ). Because this interrupt is of lower priority, it is simply held, and the communications ISR runs to completion.

When the communications ISR is complete ( $t = 25$ ), the previous processor state is restored, which is the execution of the printer ISR. However, before even a single instruction in that routine can be executed, the processor honors the higher priority disk interrupt and control transfers to the disk ISR. Only when that routine is complete ( $t = 35$ ) is the printer ISR resumed. When that routine completes ( $t = 40$ ), control finally returns to the user program.



## I/O Function

- I/O module can exchange data directly with the processor
- Processor can read data from or write data to an I/O module
  - Processor identifies a specific device that is controlled by a particular I/O module
  - I/O instructions rather than memory referencing instructions
- In some cases it is desirable to allow I/O exchanges to occur directly with memory
  - The processor grants to an I/O module the authority to read from or write to memory so that the I/O memory transfer can occur without tying up the processor
  - The I/O module issues read or write commands to memory relieving the processor of responsibility for the exchange
  - This operation is known as direct memory access (DMA)

An I/O module (e.g., a disk controller) can exchange data directly with the processor. Just as the processor can initiate a read or write with memory, designating the address of a specific location, the processor can also read data from or write data to an I/O module. In this latter case, the processor identifies a specific device that is controlled by a particular I/O module. Thus, an instruction sequence similar in form to that of Figure 3.5 could occur, with I/O instructions rather than memory-referencing instructions.

In some cases, it is desirable to allow I/O exchanges to occur directly with memory. In such a case, the processor grants to an I/O module the authority to read from or write to memory, so that the I/O-memory transfer can occur without tying up the processor. During such a transfer, the I/O module issues read or write commands to memory, relieving the processor of responsibility for the exchange. This operation is known as direct memory access (DMA) and is examined in Chapter 7.

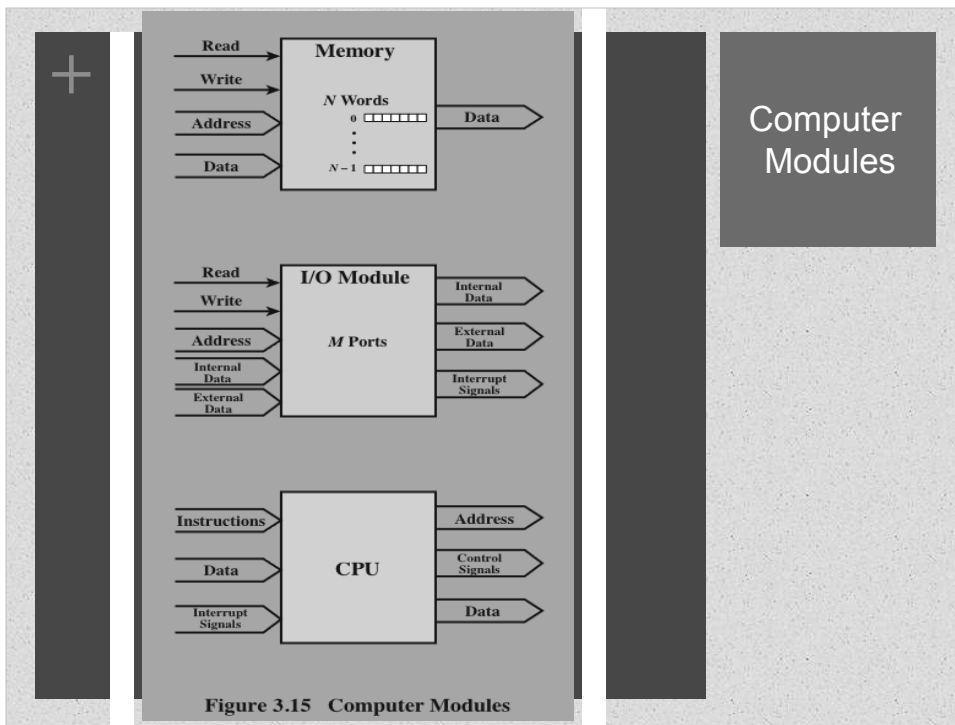

A computer consists of a set of components or modules of three basic types (processor, memory, I/O) that communicate with each other. In effect, a computer is a network of basic modules. Thus, there must be paths for connecting the modules.

The collection of paths connecting the various modules is called the *interconnection structure*. The design of this structure will depend on the exchanges that must be made among modules.

Figure 3.15 suggests the types of exchanges that are needed by indicating the major forms of input and output for each module type:

- **Memory:** Typically, a memory module will consist of  $N$  words of equal length. Each word is assigned a unique numerical address (0, 1, ...,  $N-1$ ). A word of data can be read from or written into the memory. The nature of the operation is indicated by read and write control signals. The location for the operation is specified by an address.
- **I/O module:** From an internal (to the computer system) point of view, I/O is functionally similar to memory. There are two operations, read and write. Further, an I/O module may control more than one external device. We can refer to each of the interfaces to an external device as a *port* and give each a unique address (e.g., 0, 1, ...,  $M-1$ ). In addition, there are external data paths for the input and output of data with an external device. Finally, an I/O module may be able to send interrupt signals to the processor.
- **Processor:** The processor reads in instructions and data, writes out data after processing, and uses control signals to control the overall operation of the system. It also receives interrupt signals.



The interconnection structure must support the following types of transfers:

The preceding list defines the data to be exchanged. The interconnection structure must support the following types of transfers:

- **Memory to processor:** The processor reads an instruction or a unit of data from memory.
- **Processor to memory:** The processor writes a unit of data to memory.
- **I/O to processor:** The processor reads data from an I/O device via an I/O module.
- **Processor to I/O:** The processor sends data to the I/O device.
- **I/O to or from memory:** For these two cases, an I/O module is allowed to exchange data directly with memory, without going through the processor, using direct memory access.

Over the years, a number of interconnection structures have been tried. By far the most common are (1) the bus and various multiple-bus structures, and (2) point-to-point interconnection structures with packetized data transfer. We devote the remainder of this chapter for a discussion of these structures.

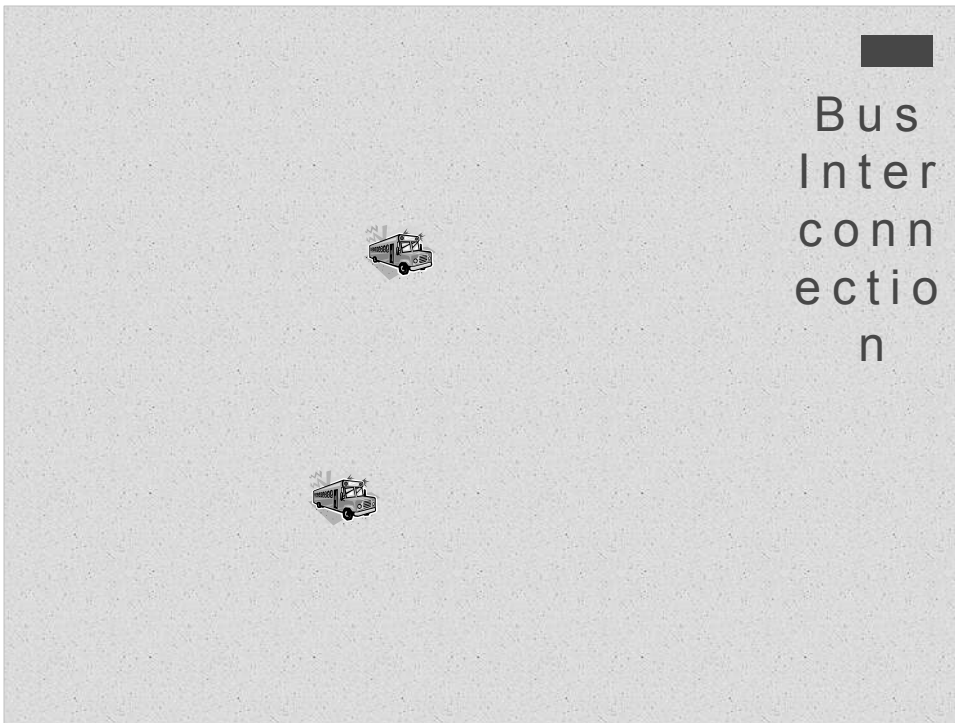

A bus is a communication pathway connecting two or more devices. A key characteristic of a bus is that it is a shared transmission medium. Multiple devices connect to the bus, and a signal transmitted by any one device is available for reception by all other devices attached to the bus. If two devices transmit during the same time period, their signals will overlap and become garbled. Thus, only one device at a time can successfully transmit.

Typically, a bus consists of multiple communication pathways, or lines. Each line is capable of transmitting signals representing binary 1 and binary 0. Over time, a sequence of binary digits can be transmitted across a single line. Taken together, several lines of a bus can be used to transmit binary digits simultaneously (in parallel). For example, an 8-bit unit of data can be transmitted over eight bus lines.

Computer systems contain a number of different buses that provide pathways between components at various levels of the computer system hierarchy. A bus that connects major computer components (processor, memory, I/O) is called a **system bus**. The most common computer interconnection structures are based on the use of one or more system buses.

## Data Bus

- Data lines that provide a path for moving data among system modules
- May consist of 32, 64, 128, or more separate lines
- The number of lines is referred to as the *width* of the data bus
- The number of lines determines how many bits can be transferred at a time
- The width of the data bus is a key factor in determining overall system performance

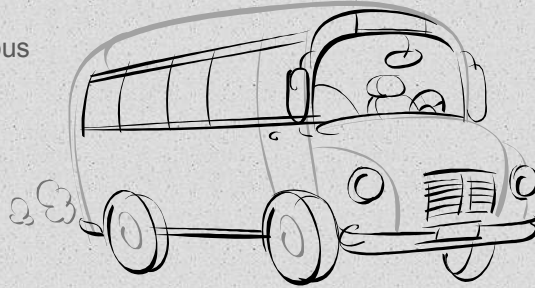

A system bus consists, typically, of from about fifty to hundreds of separate lines.

The **data lines** provide a path for moving data among system modules. These lines, collectively, are called the **data bus**. The data bus may consist of 32, 64, 128, or even more separate lines, the number of lines being referred to as the *width of the data bus*. Because each line can carry only 1 bit at a time, the number of lines determines how many bits can be transferred at a time. The width of the data bus is a key factor in determining overall system performance. For example, if the data bus is 32 bits wide and each instruction is 64 bits long, then the processor must access the memory module twice during each instruction cycle.

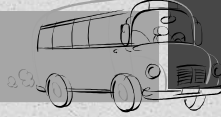
|  |   |
|--|---|
| <p>+</p> <h2 style="text-align: center;">Address Bus</h2>  <ul style="list-style-type: none"> <li>■ Used to designate the source or destination of the data on the data bus <ul style="list-style-type: none"> <li>■ If the processor wishes to read a word of data from memory it puts the address of the desired word on the address lines</li> </ul> </li> <li>■ Width determines the maximum possible memory capacity of the system</li> <li>■ Also used to address I/O ports <ul style="list-style-type: none"> <li>■ The higher order bits are used to select a particular module on the bus and the lower order bits select a memory location or I/O port within the module</li> </ul> </li> </ul> | <h2 style="text-align: center;">Control Bus</h2>  <ul style="list-style-type: none"> <li>■ Used to control the access and the use of the data and address lines</li> <li>■ Because the data and address lines are shared by all components there must be a means of controlling their use</li> <li>■ Control signals transmit both command and timing information among system modules</li> <li>■ Timing signals indicate the validity of data and address information</li> <li>■ Command signals specify operations to be performed</li> </ul> |
|--|---|

The **address lines** are used to designate the source or destination of the data on the data bus. For example, if the processor wishes to read a word (8, 16, or 32 bits) of data from memory, it puts the address of the desired word on the address lines. Clearly, the width of the **address bus** determines the maximum possible memory capacity of the system. Furthermore, the address lines are generally also used to address I/O ports. Typically, the higher-order bits are used to select a particular module on the bus, and the lower-order bits select a memory location or I/O port within the module. For example, on an 8-bit address bus, address 01111111 and below might reference locations in a memory module (module 0) with 128 words of memory, and address 10000000 and above refer to devices attached to an I/O module (module 1).

The **control lines** are used to control the access to and the use of the data and address lines. Because the data and address lines are shared by all components, there must be a means of controlling their use. Control signals transmit both command and timing information among system modules. Timing signals indicate the validity of data and address information. Command signals specify operations to be performed. Typical control lines include:

- **Memory write:** causes data on the bus to be written into the addressed location
- **Memory read:** causes data from the addressed location to be placed on the bus
- **I/O write:** causes data on the bus to be output to the addressed I/O port

## Bus Interconnection Scheme

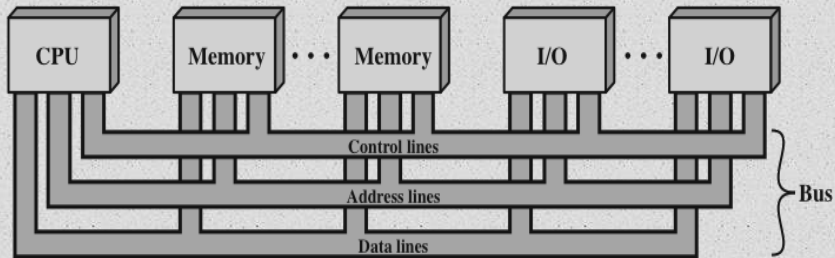
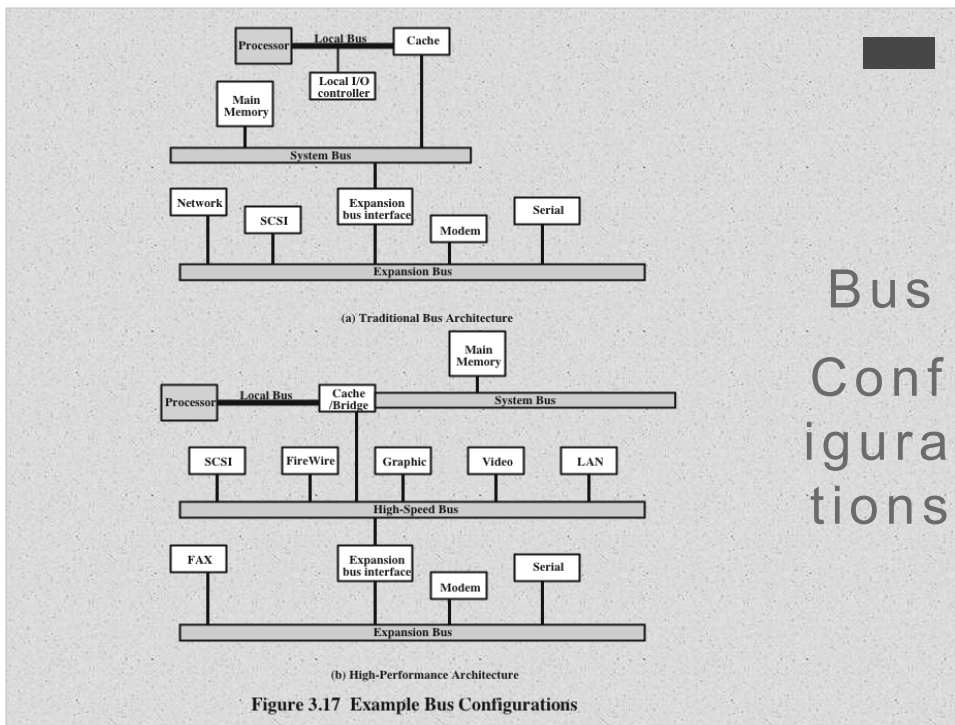

Figure 3.16 Bus Interconnection Scheme

The operation of the bus is as follows. If one module wishes to send data to another, it must do two things: (1) obtain the use of the bus, and (2) transfer data via the bus. If one module wishes to request data from another module, it must (1) obtain the use of the bus, and (2) transfer a request to the other module over the appropriate control and address lines. It must then wait for that second module to send the data.



# Bus Configurations

If a great number of devices are connected to the bus, performance will suffer.

There are two main causes:

1. In general, the more devices attached to the bus, the greater the bus length and hence the greater the propagation delay. This delay determines the time it takes for devices to coordinate the use of the bus. When control of the bus passes from one device to another frequently, these propagation delays can noticeably affect performance.

2. The bus may become a bottleneck as the aggregate data transfer demand approaches the capacity of the bus. This problem can be countered to some extent by increasing the data rate that the bus can carry and by using wider buses (e.g., increasing the data bus from 32 to 64 bits). However, because the data rates generated by attached devices (e.g., graphics and video controllers, network interfaces) are growing rapidly, this is a race that a single bus is ultimately destined to lose.

Accordingly, most bus-based computer systems use multiple buses, generally laid out in a hierarchy. A typical traditional structure is shown in Figure 3.17a. There is a local bus that connects the processor to a cache memory and that may support one or more local devices. The cache memory controller connects the cache not only to this local bus, but to a system bus to which are attached all of the main memory modules. In contemporary systems, the cache is in the same chip as the processor, and so an external bus or other interconnect scheme is not needed, although there may also be an external cache. As will be discussed in Chapter 4, the use of a cache structure insulates the processor from a requirement to access main memory frequently.



# Elements of Bus Design

|                              |                           |
|------------------------------|---------------------------|
| <b>Type</b>                  | <b>Bus Width</b>          |
| Dedicated                    | Address                   |
| Multiplexed                  | Data                      |
| <b>Method of Arbitration</b> | <b>Data Transfer Type</b> |
| Centralized                  | Read                      |
| Distributed                  | Write                     |
| <b>Timing</b>                | Read-modify-write         |
| Synchronous                  | Read-after-write          |
| Asynchronous                 | Block                     |

Although a variety of different bus implementations exist, there are a few basic parameters or design elements that serve to classify and differentiate buses. Table 3.2 lists key elements.

**Bus Types:** Bus lines can be separated into two generic types: dedicated and multiplexed. A dedicated bus line is permanently assigned either to one function or to a physical subset of computer components.

An example of functional dedication is the use of separate dedicated address and data lines, which is common on many buses. However, it is not essential. For example, address and data information may be transmitted over the same set of lines using an Address Valid control line. At the beginning of a data transfer, the address is placed on the bus and the Address Valid line is activated. At this point, each module has a specified period of time to copy the address and determine if it is the addressed module. The address is then removed from the bus, and the same bus connections are used for the subsequent read or write data transfer. This method of using the same lines for multiple purposes is known as *time multiplexing*.

The advantage of time multiplexing is the use of fewer lines, which saves space and, usually, cost. The disadvantage is that more complex circuitry is needed within each module. Also, there is a potential reduction in performance because certain events that share the same lines cannot take place in parallel.

*Physical dedication* refers to the use of multiple buses, each of which connects only a subset of modules. A typical example is the use of an I/O bus to interconnect all I/O modules; this bus is then connected to the main bus through some type of I/O adapter module. The potential advantage of physical dedication is high throughput, because there is less bus contention. A disadvantage is the increased size and cost of the system.

**Method of arbitration:** In all but the simplest systems, more than one module may need control of the bus. For example, an I/O module may need to read or write directly to memory, without sending the data to the processor. Because only one unit at a time can successfully transmit over the bus, some method of **arbitration** is needed. The various methods can be roughly classified as being either **centralized arbitration** or **distributed arbitration**. In a centralized scheme, a single hardware device, referred to as a *bus controller or arbiter*, is responsible for allocating time on the bus. The device may be a separate module or part of the processor. In a distributed scheme, there is no central controller. Rather, each module contains access control logic and the modules act together to share the bus. With both methods of arbitration, the purpose is to designate one device, either the processor or an I/O module, as master. The master may then initiate a data transfer (e.g., read or write) with some other device, which acts as slave for this particular exchange.

**Timing:** Timing refers to the way in which events are coordinated on the bus. Buses use either synchronous timing or asynchronous timing.

## Timing of Synchronous Bus Operations

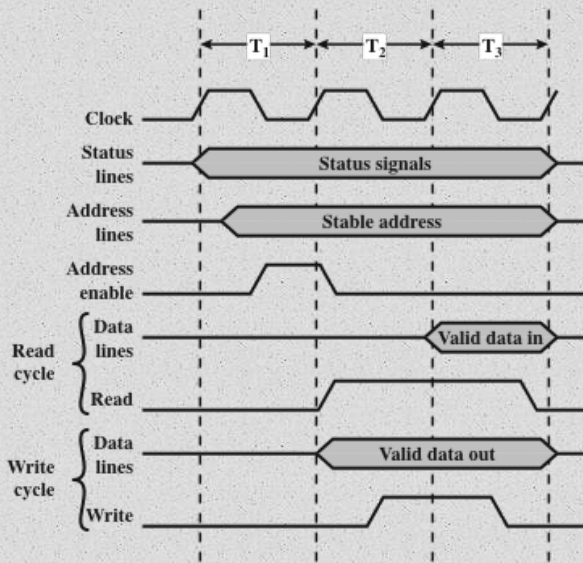
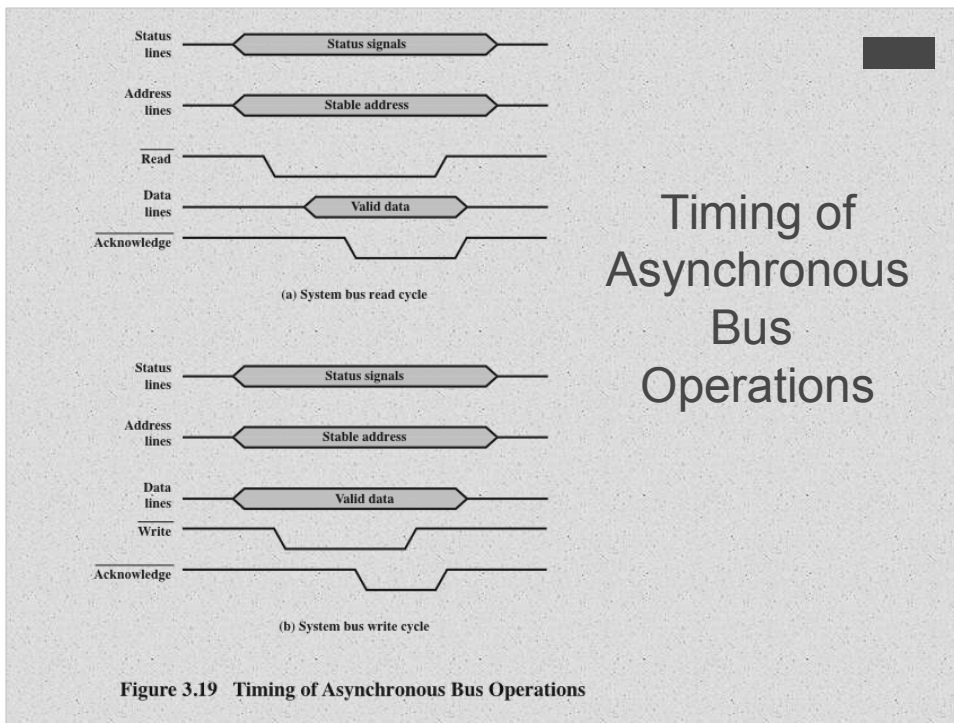

**Figure 3.18 Timing of Synchronous Bus Operations**

With **synchronous timing**, the occurrence of events on the bus is determined by a clock. The bus includes a clock line upon which a clock transmits a regular sequence of alternating 1s and 0s of equal duration. A single 1–0 transmission is referred to as a *clock cycle or bus cycle* and defines a time slot. All other devices on the bus can read the clock line, and all events start at the beginning of a clock cycle.

Figure 3.18 shows a typical, but simplified, timing diagram for synchronous read and write operations (see Appendix N for a description of timing diagrams). Other bus signals may change at the leading edge of the clock signal (with a slight reaction delay). Most events occupy a single clock cycle. In this simple example, the processor places a memory address on the address lines during the first clock cycle and may assert various status lines. Once the address lines have stabilized, the processor issues an address enable signal. For a read operation, the processor issues a read command at the start of the second cycle. A memory module recognizes the address and, after a delay of one cycle, places the data on the data lines. The processor reads the data from the data lines and drops the read signal. For a write operation, the processor puts the data on the data lines at the start of the second cycle and issues a write command after the data lines have stabilized. The memory module copies the information from the data lines during the third clock cycle.





With **asynchronous timing**, the occurrence of one event on a bus follows and depends on the occurrence of a previous event. In the simple read example of Figure 3.19a, the processor places address and status signals on the bus. After pausing for these signals to stabilize, it issues a read command, indicating the presence of valid address and control signals. The appropriate memory decodes the address and responds by placing the data on the data line. Once the data lines have stabilized, the memory module asserts the acknowledged line to signal the processor that the data are available. Once the master has read the data from the data lines, it deasserts the read signal. This causes the memory module to drop the data and acknowledge lines. Finally, once the acknowledge line is dropped, the master removes the address information.

Figure 3.19b shows a simple asynchronous write operation. In this case, the master places the data on the data line at the same time that it puts signals on the status and address lines. The memory module responds to the write command by copying the data from the data lines and then asserting the acknowledge line. The master then drops the write signal and the memory module drops the acknowledge signal.

Synchronous timing is simpler to implement and test. However, it is less flexible than asynchronous timing. Because all devices on a synchronous bus are tied to a fixed clock rate, the system cannot take advantage of advances in device performance. With asynchronous timing, a mixture of slow and fast devices, using older and newer technology, can share a bus.



## Point-to-Point Interconnect



The shared bus architecture was the standard approach to interconnection between the processor and other components (memory, I/O, and so on) for decades. But contemporary systems increasingly rely on point-to-point interconnection rather than shared buses.

The principal reason driving the change from bus to point-to-point interconnect was the electrical constraints encountered with increasing the frequency of wide synchronous buses. At higher and higher data rates, it becomes increasingly difficult to perform the synchronization and arbitration functions in a timely fashion. Further, with the advent of multi-core chips, with multiple processors and significant memory on a single chip, it was found that the use of a conventional shared bus on the same chip magnified the difficulties of increasing bus data rate and reducing bus latency to keep up interconnect has lower latency, higher data rate, and better scalability.

# + Quick Path Interconnect

- Introduced in 2008
- Multiple direct connections
  - Direct pairwise connections to other components eliminating the need for arbitration found in shared transmission systems
- Layered protocol architecture
  - These processor level interconnects use a layered protocol architecture rather than the simple use of control signals found in shared bus arrangements
- Packetized data transfer
  - Data are sent as a sequence of packets each of which includes control headers and error control codes

QPI

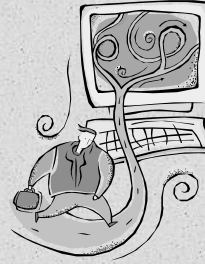

In this section, we look at an important and representative example of the point-to-point interconnect approach: Intel's **QuickPath Interconnect (QPI)**, which was introduced in 2008.

The following are significant characteristics of QPI and other point-to-point interconnect schemes:

- **Multiple direct connections:** Multiple components within the system enjoy direct pairwise connections to other components. This eliminates the need for arbitration found in shared transmission systems.
- **Layered protocol architecture:** As found in network environments, such as TCP/IP-based data networks, these processor-level interconnects use a layered protocol architecture, rather than the simple use of control signals found in shared bus arrangements.
- **Packetized data transfer:** Data are not sent as a raw bit stream. Rather, data are sent as a sequence of packets, each of which includes control headers and error control codes.

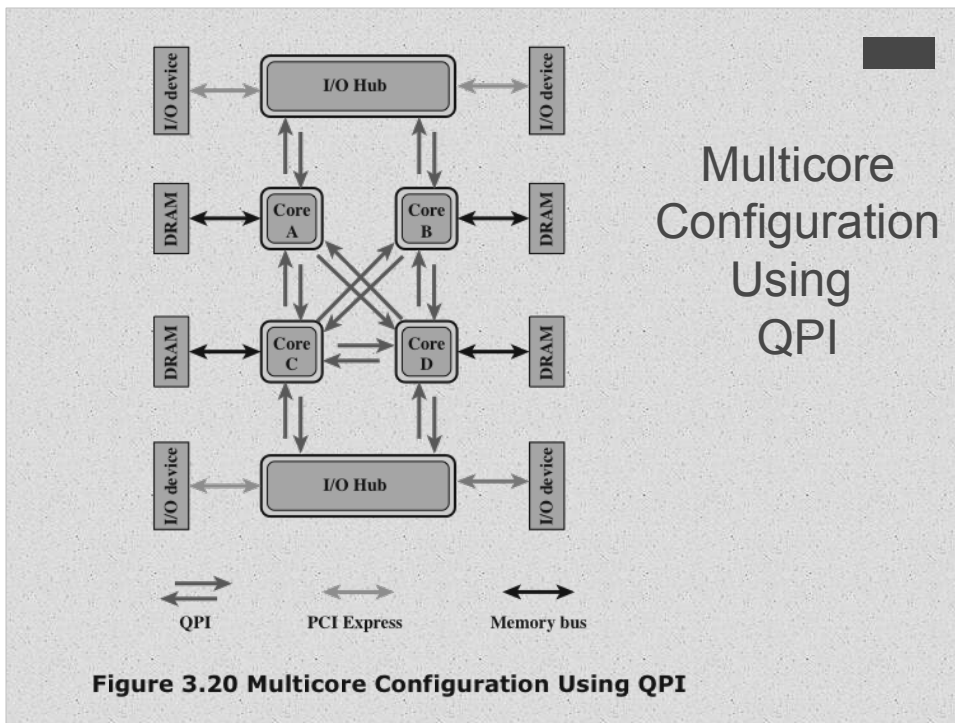
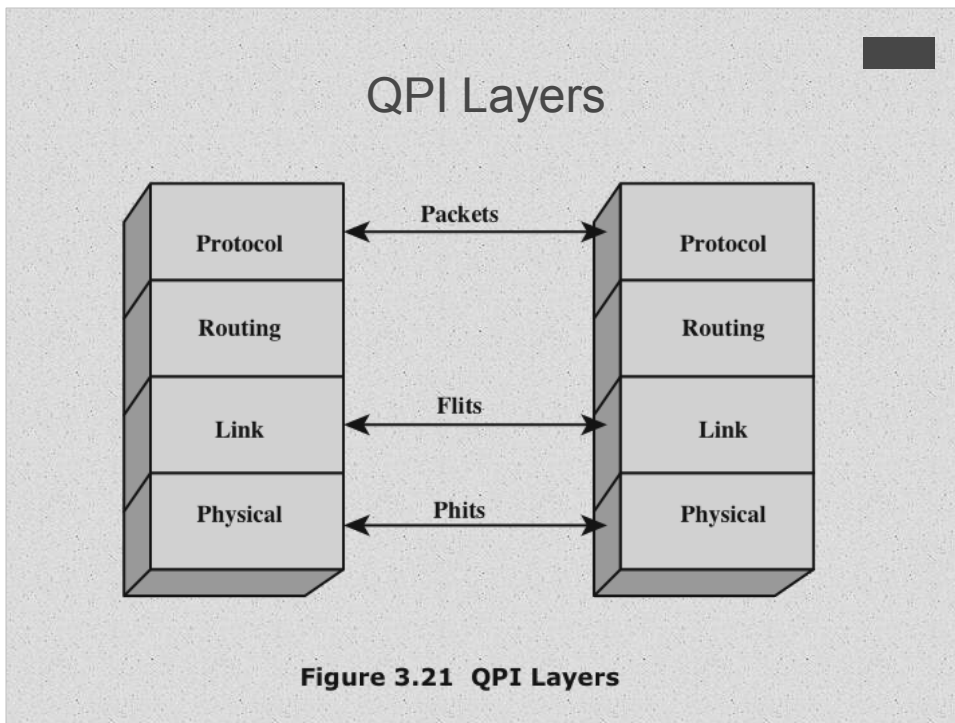

Figure 3.20 illustrates a typical use of QPI on a multi-core computer. The QPI links (indicated by the green arrow pairs in the figure) form a switching fabric that enables data to move throughout the network. Direct QPI connections can be established between each pair of core processors. If core A in Figure 3.20 needs to access the memory controller in core D, it sends its request through either cores B or C, which must in turn forward that request on to the memory controller in core D. Similarly, larger systems with eight or more processors can be built using processors with three links and routing traffic through intermediate processors.

In addition, QPI is used to connect to an I/O module, called an I/O hub (IOH). The IOH acts as a switch directing traffic to and from I/O devices. Typically in newer systems, the link from the IOH to the I/O device controller uses an interconnect technology called PCI Express (PCIe), described later in this chapter. The IOH translates between the QPI protocols and formats and the PCIe protocols and formats. A core also links to a main memory module (typically the memory uses dynamic access random memory (DRAM) technology) using a dedicated memory bus.



QPI is defined as a four-layer protocol architecture, encompassing the following layers (Figure 3.21):

- **Physical:** Consists of the actual wires carrying the signals, as well as circuitry and logic to support ancillary features required in the transmission and receipt of the 1s and 0s. The unit of transfer at the Physical layer is 20 bits, which is called a **Phit** (physical unit).

**Link:** Responsible for reliable transmission and flow control. The Link layer's unit of transfer is an 80-bit **Flit** (flow control unit).

- **Routing:** Provides the framework for directing packets through the fabric.

- **Protocol:** The high-level set of rules for exchanging **packets** of data between devices. A packet is comprised of an integral number of Flits.

## + Physical Interface of the Intel QPI Interconnect

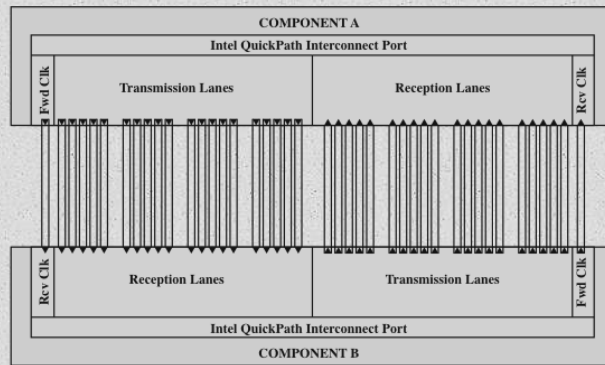

Figure 3.22 Physical Interface of the Intel QPI Interconnect

Figure 3.22 shows the physical architecture of a QPI port. The QPI port consists of 84 individual links grouped as follows. Each data path consists of a pair of wires that transmits data one bit at a time; the pair is referred to as a **lane**. There are 20 data lanes in each direction (transmit and receive), plus a clock lane in each direction. Thus, QPI is capable of transmitting 20 bits in parallel in each direction. The 20-bit unit is referred to as a *phit*. Typical signaling speeds of the link in current products calls for operation at 6.4 GT/s (transfers per second). At 20 bits per transfer, that adds up to 16 GB/s, and since QPI links involve dedicated bidirectional pairs, the total capacity is 32 GB/s.

The lanes in each direction are grouped into four quadrants of 5 lanes each.

In some applications, the link can also operate at half or quarter widths in order to reduce power consumption or work around failures.

The form of transmission on each lane is known as **differential signaling, or balanced transmission**. With balanced transmission, signals are transmitted as a current that travels down one conductor and returns on the other. The binary value depends on the voltage difference. Typically, one line has a positive voltage value and the other line has zero voltage, and one line is associated with binary 1 and one line is associated with binary 0. Specifically, the technique used by QPI is known as *low-voltage differential signaling (LVDS)*. In a typical implementation, the transmitter injects a small current into one wire or the other, depending on the logic level to be sent. The current passes through a resistor at the receiving end, and then returns in the opposite direction along the other wire. The receiver senses the polarity of the voltage across the resistor to determine the logic level.

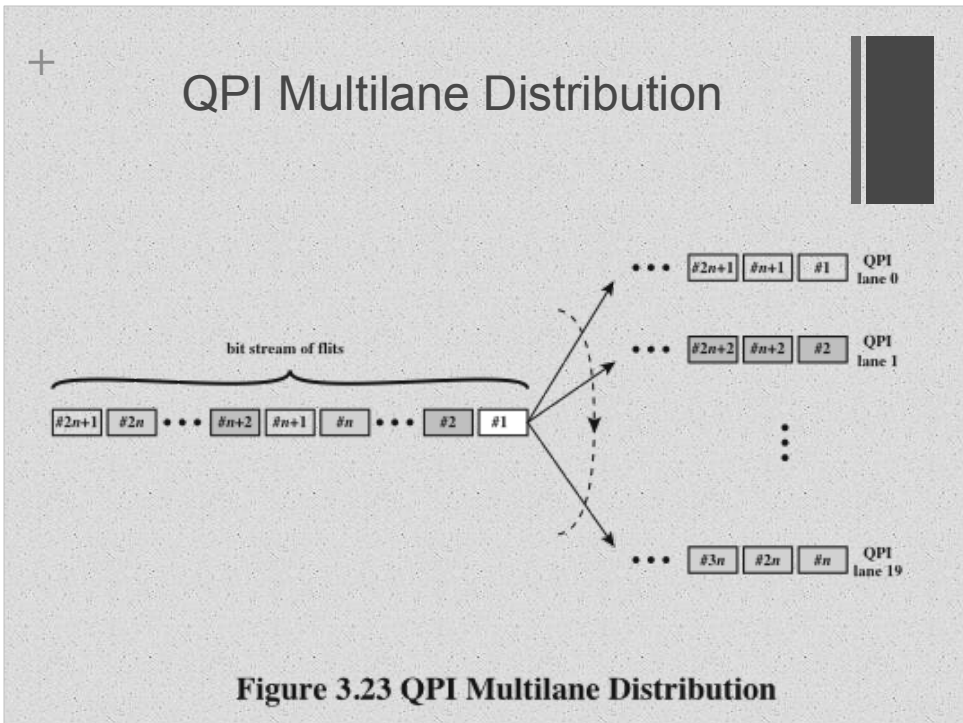

Another function performed by the physical layer is that it manages the translation between 80-bit flits and 20-bit phits using a technique known as **multilane distribution**. The flits can be considered as a bit stream that is distributed across the data lanes in a round-robin fashion (first bit to first lane, second bit to second lane, etc.), as illustrated in Figure 3.23. This approach enables QPI to achieve very high data rates by implementing the physical link between two ports as multiple parallel channels.

## + QPI Link Layer

- Performs two key functions: *flow control* and *error control*
  - Operate on the level of the flit (flow control unit)
  - Each flit consists of a 72-bit message payload and an 8-bit error control code called a *cyclic redundancy check* (CRC)
- Flow control function
  - Needed to ensure that a sending QPI entity does not overwhelm a receiving QPI entity by sending data faster than the receiver can process the data and clear buffers for more incoming data
- Error control function
  - Detects and recovers from bit errors, and so isolates higher layers from experiencing bit errors

The QPI link layer performs two key functions: flow control and error control. These functions are performed as part of the QPI link layer protocol, and operate on the level of the flit (flow control unit). Each flit consists of a 72-bit message payload and an 8-bit error control code called a cyclic redundancy check (CRC). We discuss error control codes in Chapter 5.

A flit payload may consist of data or message information. The data flits transfer the actual bits of data between cores or between a core and an IOH. The message flits are used for such functions as flow control, error control, and cache coherence. We discuss cache coherence in Chapters 5 and 17.

The **flow control function** is needed to ensure that a sending QPI entity does not overwhelm a receiving QPI entity by sending data faster than the receiver can process the data and clear buffers for more incoming data. To control the flow of data, QPI makes use of a credit scheme. During initialization, a sender is given a set number of credits to send flits to a receiver. Whenever a flit is sent to the receiver, the sender decrements its credit counters by one credit. Whenever a buffer is freed at the receiver, a credit is returned to the sender for that buffer. Thus, the receiver controls that pace at which data is transmitted over a QPI link.

Occasionally, a bit transmitted at the physical layer is changed during transmission, due to noise or some other phenomenon. The **error control** function at the link layer detects and recovers from such bit errors, and so isolates higher layers from experiencing bit errors. The procedure works as follows for a flow of data from system A to system B:





# QPI Routing and Protocol Layers

## Routing Layer

- Used to determine the course that a packet will traverse across the available system interconnects
- Defined by firmware and describe the possible paths that a packet can follow

## Protocol Layer

- Packet is defined as the unit of transfer
- One key function performed at this level is a cache coherency protocol which deals with making sure that main memory values held in multiple caches are consistent
- A typical data packet payload is a block of data being sent to or from a cache.

The Routing layer is used to determine the course that a packet will traverse across the available system interconnects. Routing tables are defined by firmware and describe the possible paths that a packet can follow. In small configurations, such as a two-socket platform, the routing options are limited and the routing tables quite simple. For larger systems, the routing table options are more complex, giving the flexibility of routing and rerouting traffic depending on how (1) devices are populated in the platform, (2) system resources are partitioned, and (3) reliability events result in mapping around a failing resource.

In this layer, the packet is defined as the unit of transfer. The packet contents definition is standardized with some flexibility allowed to meet differing market segment requirements. One key function performed at this level is a cache coherency protocol, which deals with making sure that main memory values held in multiple caches are consistent. A typical data packet payload is a block of data being sent to or from a cache.



## Peripheral Component Interconnect (PCI)

- A popular high bandwidth, processor independent bus that can function as a mezzanine or peripheral bus
- Delivers better system performance for high speed I/O subsystems
- PCI Special Interest Group (SIG)
  - Created to develop further and maintain the compatibility of the PCI specifications
- PCI Express (PCIe)
  - Point-to-point interconnect scheme intended to replace bus-based schemes such as PCI
  - Key requirement is high capacity to support the needs of higher data rate I/O devices, such as Gigabit Ethernet
  - Another requirement deals with the need to support time dependent data streams

The **peripheral component interconnect (PCI)** is a popular high-bandwidth, processor independent bus that can function as a mezzanine or peripheral bus. Compared with other common bus specifications, PCI delivers better system performance for high speed I/O subsystems (e.g., graphic display adapters, network interface controllers, and disk controllers).

Intel began work on PCI in 1990 for its Pentium-based systems. Intel soon released all the patents to the public domain and promoted the creation of an industry association, the PCI Special Interest Group (SIG), to develop further and maintain the compatibility of the PCI specifications. The result is that PCI has been widely adopted and is finding increasing use in personal computer, workstation, and server systems. Because the specification is in the public domain and is supported by a broad cross section of the microprocessor and peripheral industry, PCI products built by different vendors are compatible.

As with the system bus discussed in the preceding sections, the bus-based PCI scheme has not been able to keep pace with the data rate demands of attached devices. Accordingly, a new version, known as **PCI Express (PCIe)** has been developed. PCIe, as with QPI, is a point-to-point interconnect scheme intended to replace bus-based schemes such as PCI.

A key requirement for PCIe is high capacity to support the needs of higher data rate I/O devices, such as Gigabit Ethernet. Another requirement deals with the need to support time-dependent data streams. Applications such as video-on-demand and audio redistribution are putting real-time constraints on servers too. Many communications applications and embedded PC control systems also process data in real-

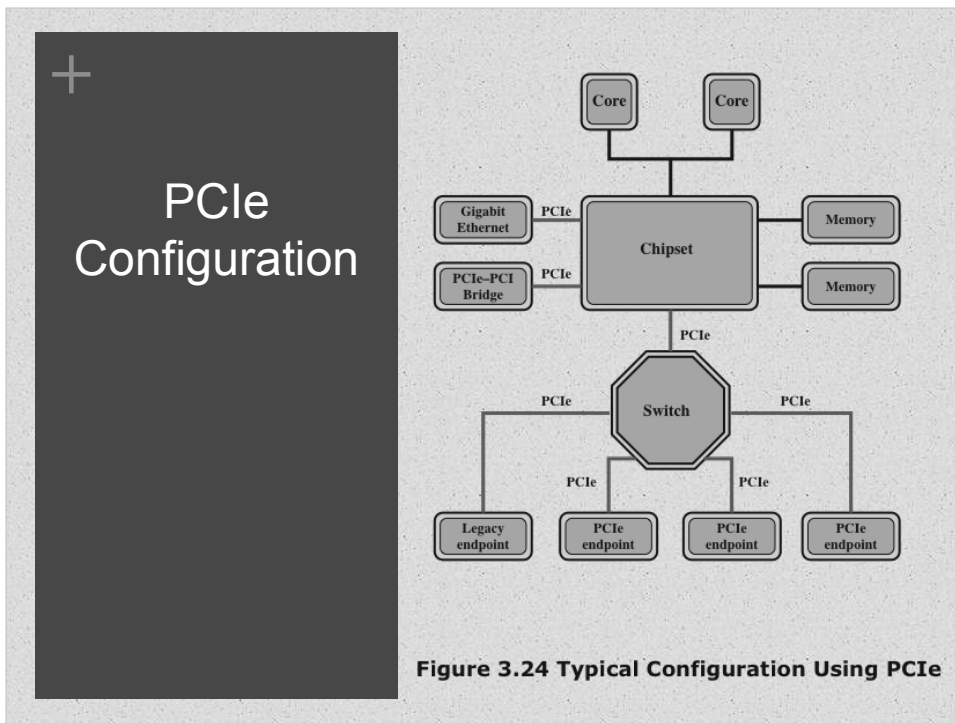
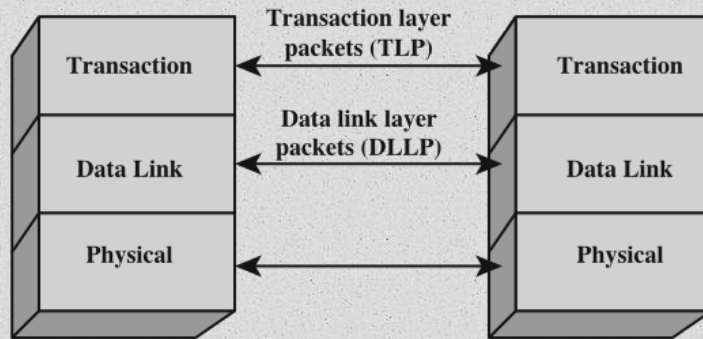

Figure 3.24 shows a typical configuration that supports the use of PCIe. A **root complex** device, also referred to as a *chipset* or a *host bridge*, connects the processor and memory subsystem to the PCI Express switch fabric comprising one or more PCIe and PCIe switch devices. The root complex acts as a buffering device, to deal with difference in data rates between I/O controllers and memory and processor components. The root complex also translates between PCIe transaction formats and the processor and memory signal and control requirements. The chipset will typically support multiple PCIe ports, some of which attach directly to a PCIe device and one or more that attach to a switch that manages multiple PCIe streams. PCIe links from the chipset may attach to the following kinds of devices that implement PCIe:

- **Switch:** The switch manages multiple PCIe streams.
- **PCIe endpoint:** An I/O device or controller that implements PCIe, such as a Gigabit Ethernet switch, a graphics or video controller, disk interface, or a communications controller.
- **Legacy endpoint:** Legacy endpoint category is intended for existing designs that have been migrated to PCI Express, and it allows legacy behaviors such as use of I/O space and locked transactions. PCI Express endpoints are not permitted to require the use of I/O space at runtime and must not use locked transactions. By distinguishing these categories, it is possible for a system designer to restrict or eliminate legacy behaviors that have negative impacts on system performance and robustness.

+

## PCIe Protocol Layers



**Figure 3.25 PCIe Protocol Layers**

As with QPI, PCIe interactions are defined using a protocol architecture. The PCIe protocol architecture encompasses the following layers (Figure 3.25):

**Physical:** Consists of the actual wires carrying the signals, as well as circuitry and logic to support ancillary features required in the transmission and receipt of the 1s and 0s.

• **Data link:** Is responsible for reliable transmission and flow control. Data packets generated and consumed by the DLL are called Data Link Layer Packets (DLLPs).

• **Transaction:** Generates and consumes data packets used to implement load/store data transfer mechanisms and also manages the flow control of those packets between the two components on a link. Data packets generated and consumed by the TL are called Transaction Layer Packets (TLPs).

Above the TL are software layers that generate read and write requests that are transported by the transaction layer to the I/O devices using a packet-based transaction protocol.

+

# PCIe Multilane Distribution

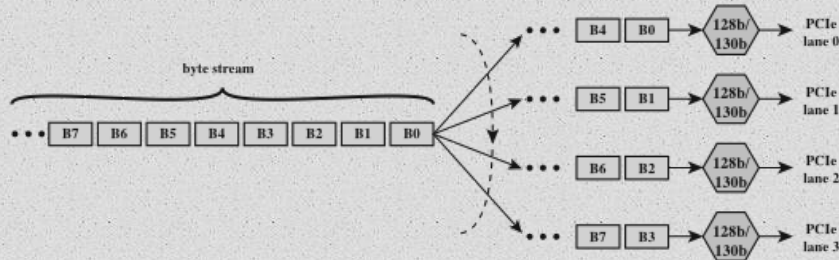
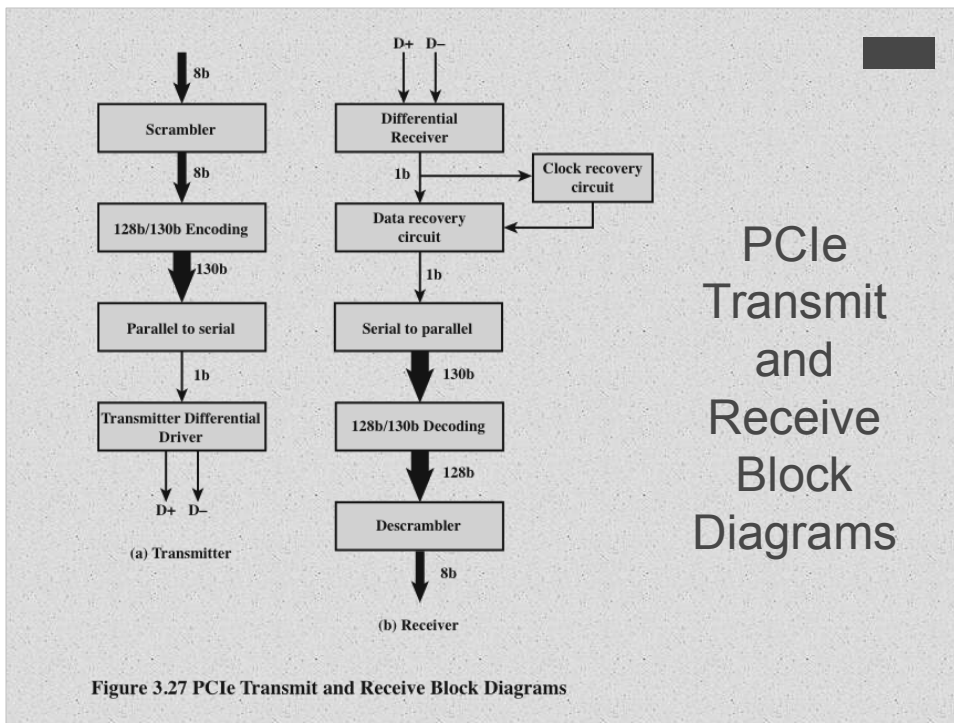

**Figure 3.26 PCIe Multilane Distribution**

Similar to QPI, PCIe is a point-to-point architecture. Each PCIe port consists of a number of bidirectional lanes (note that in QPI, the lane refers to transfer in one direction only). Transfer in each direction in a lane is by means of differential signaling over a pair of wires. A PCI port can provide 1, 4, 6, 16, or 32 lanes. In what follows, we refer to the PCIe 3.0 specification, introduced in late 2010.

As with QPI, PCIe uses a multilane distribution technique. Figure 3.26 shows an example for a PCIe port consisting of four lanes. Data are distributed to the four lanes 1 byte at a time using a simple round-robin scheme. At each physical lane, data are buffered and processed 16 bytes (128 bits) at a time. Each block of 128 bits is encoded into a unique 130-bit codeword for transmission; this is referred to as 128b/130b encoding. Thus, the effective data rate of an individual lane is reduced by a factor of 128/130.

To understand the rationale for the 128b/130b encoding, note that unlike QPI, PCIe does not use its clock line to synchronize the bit stream. That is, the clock line is not used to determine the start and end point of each incoming bit; it is used for other signaling purposes only. However, it is necessary for the receiver to be synchronized with the transmitter, so that the receiver knows when each bit begins and ends. If there is any drift between the clocks used for bit transmission and reception of the transmitter and receiver, errors may occur. To compensate for the possibility of drift, PCIe relies on the receiver synchronizing with the transmitter based on the transmitted signal. As with QPI, PCIe uses differential signaling over a pair of wires. Synchronization can be achieved by the receiver looking for transitions in the data and synchronizing its clock to the transition. However, consider that with a long string of 1s or 0s using differential signaling, the output is a



A common approach, and the one used in PCIe 3.0, to overcoming the problem of a long string of bits of one value is scrambling. Scrambling, which does not increase the number of bits to be transmitted, is a mapping technique that tends to make the data appear more random. The scrambling tends to spread out the number of transitions so that they appear at the receiver more uniformly spaced, which is good for synchronization. Also, other transmission properties, such as spectral properties, are enhanced if the data are more nearly of a random nature rather than constant or repetitive. For more discussion of scrambling, see Appendix M.

Another technique that can aid in synchronization is encoding, in which additional bits are inserted into the bit stream to force transitions. For PCIe 3.0, each group of 128 bits of input is mapped into a 130-bit block by adding a 2-bit block sync header. The value of the header is 10 for a data block and 01 for what is called an *ordered set block*, which refers to a link-level information block.

Figure 3.27 illustrates the use of scrambling and encoding. Data to be transmitted are fed into a scrambler. The scrambled output is then fed into a 128b/130b encoder, which buffers 128 bits and then maps the 128-bit block into a 130-bit block. This block then passes through a parallel-to-serial converter and transmitted one bit at a time using differential signaling.

At the receiver, a clock is synchronized to the incoming data to recover the bit stream. This then passes through a serial-to-parallel converter to produce a stream of 130-bit blocks. Each block is passed through a 128b/130b decoder to recover the original scrambled bit pattern, which is then descrambled to produce

+

PCIe  
Transaction Layer (TL)



- Receives read and write requests from the software above the TL and creates request packets for transmission to a destination via the link layer
- Most transactions use a *split transaction* technique
  - A request packet is sent out by a source PCIe device which then waits for a response called a *completion* packet
- TL messages and some write transactions are *posted transactions* (meaning that no response is expected)
- TL packet format supports 32-bit memory addressing and extended 64-bit memory addressing

The transaction layer (TL) receives read and write requests from the software above the TL and creates request packets for transmission to a destination via the link layer. Most transactions use a *split transaction* technique, which works in the following fashion. A request packet is sent out by a source PCIe device, which then waits for a response, called a *completion* packet. The completion following a request is initiated by the completer only when it has the data and/or status ready for delivery. Each packet has a unique identifier that enables completion packets to be directed to the correct originator. With the split transaction technique, the completion is separated in time from the request, in contrast to a typical bus operation in which both sides of a transaction must be available to seize and use the bus. Between the request and the completion, other PCIe traffic may use the link.

TL messages and some write transactions are *posted transactions*, meaning that no response is expected.

The TL packet format supports 32-bit memory addressing and extended 64-bit memory addressing. Packets also have attributes such as “no-snoop,” “relaxed ordering,” and “priority,” which may be used to optimally route these packets through the I/O subsystem.

## + The TL supports four address spaces:

- **Memory**
  - The memory space includes system main memory and PCIe I/O devices
  - Certain ranges of memory addresses map into I/O devices
- **I/O**
  - This address space is used for legacy PCI devices, with reserved address ranges used to address legacy I/O devices
- **Configuration**
  - This address space enables the TL to read/write configuration registers associated with I/O devices
- **Message**
  - This address space is for control signals related to interrupts, error handling, and power management

The TL supports four address spaces:

- **Memory:** The memory space includes system main memory. It also includes PCIe I/O devices. Certain ranges of memory addresses map into I/O devices.
- **I/O:** This address space is used for legacy PCI devices, with reserved memory address ranges used to address legacy I/O devices.
- **Configuration:** This address space enables the TL to read/write configuration registers associated with I/O devices.
- **Message:** This address space is for control signals related to interrupts, error handling, and power management.



# PCIe TLP Transaction Types

| Address Space              | TLP Type                    | Purpose  |
|----------------------------|-----------------------------|--|
| Memory                     | Memory Read Request         | Transfer data to or from a location in the system memory map.                    |
|                            | Memory Read Lock Request    |  |
|                            | Memory Write Request        |  |
| I/O                        | I/O Read Request            | Transfer data to or from a location in the system memory map for legacy devices. |
|                            | I/O Write Request           |  |
| Configuration              | Config Type 0 Read Request  | Transfer data to or from a location in the configuration space of a PCIe device. |
|                            | Config Type 0 Write Request |  |
|                            | Config Type 1 Read Request  |  |
|                            | Config Type 1 Write Request |  |
| Message                    | Message Request             | Provides in-band messaging and event reporting.                                  |
|                            | Message Request with Data   |  |
| Memory, I/O, Configuration | Completion                  | Returned for certain requests.   |
|                            | Completion with Data        |  |
|                            | Completion Locked           |  |
|                            | Completion Locked with Data |  |

Table 3.3 shows the transaction types provided by the TL. For memory, I/O, and configuration address spaces, there are read and write transactions. In the case of memory transactions, there is also a read lock request function. Locked operations occur as a result of device drivers requesting atomic access to registers on a PCIe device. A device driver, for example, can atomically read, modify, and then write to a device register. To accomplish this, the device driver causes the processor to execute an instruction or set of instructions. The root complex converts these processor instructions into a sequence of PCIe transactions, which perform individual read and write requests for the device driver. If these transactions must be executed atomically, the root complex locks the PCIe link while executing the transactions. This locking prevents transactions that are not part of the sequence from occurring. This sequence of transactions is called a locked operation. The particular set of processor instructions that can cause a locked operation to occur depends on the system chip set and processor architecture.

To maintain compatibility with PCI, PCIe supports both Type 0 and Type 1 configuration cycles. A Type 1 cycle propagates downstream until it reaches the bridge interface hosting the bus (link) that the target device resides on. The configuration transaction is converted on the destination link from Type 1 to Type 0 by the bridge.

Finally, completion messages are used with split transactions for memory, I/O, and configuration transactions.

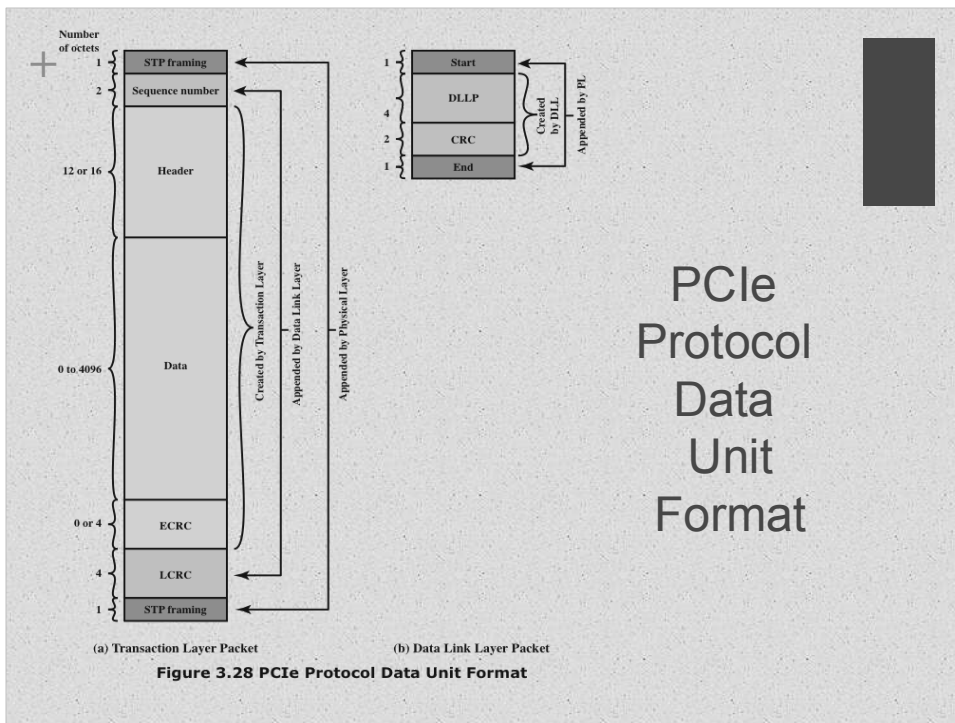

PCIe transactions are conveyed using transaction layer packets, which are illustrated in Figure 3.28a. A TLP originates in the transaction layer of the sending device and terminates at the transaction layer of the receiving device.

Upper layer software sends to the TL the information needed for the TL to create the core of the TLP, which consists of the following fields:

- **Header:** The Header describes the type of packet and includes information needed by the receiver to process the packet, including any needed routing information. The internal header format is discussed subsequently.
- **Data:** A Data field of up to 4096 bytes may be included in the TLP. Some TLPs do not contain a Data field.
- **ECRC:** An optional end-to-end CRC field enables the destination TL layer to check for errors in the Header and Data portions of the TLP.



# TLP Memory Request Format

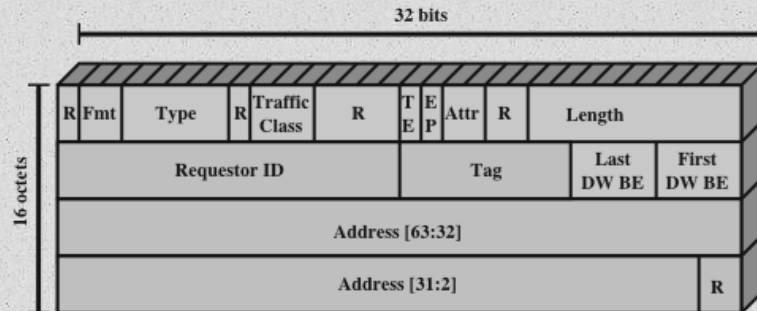

**Figure 3.29 TLP Memory Request Format**

An example of a TLP header format, used for a memory request transaction, is shown in Figure 3.29. The fields shaded green indicate fields that are present in all headers. In addition to fields reserved for future use (R), these fields include the following:

- **Length:** Length of the Data field in double words (DW), where one DW = 4 bytes.
  - **Attributes:** Consists of two bits. The *relaxed ordering bit* indicates whether strict or relaxed ordering is used. With relaxed ordering, a transaction may be completed prior to other transactions that were already enqueued. The *no snoop bit*, when set, indicates that no cache coherency issues exist with respect to this TLP.
  - **EP:** Poisoned data bit. If set, this bit indicates the data in this TLP should be considered invalid, although the transaction is being allowed to complete normally.
  - **TE:** TLP digest field present. If set, indicates that the ECRC field is present.
  - **Traffic Class:** A 3-bit traffic class can be assigned to a traffic flow to enable PCIe to prioritize service.
  - **Type, Format:** These two fields, totaling 7 bits, specify transaction type, header size, and whether a data field is present.
- First DW Byte Enables:** These four bits indicate, respectively, whether the corresponding byte in the first DW is valid.
- Last DW Byte Enables:** These four bits indicate, respectively, whether the corresponding byte in the last DW is valid. This and the preceding field have the effect of allowing smaller transfers than a full DW and offsetting the start and end addresses from the DW boundary.

Figure 3.29 shows a TLP header for a memory request transaction. The Requestor ID identifies the memory requester, telling the completer where to send its response. The Tag is a number assigned to this transaction by the requester; the completer must include this Tag in its response so that the requester can match request and response. The Address field indicates the starting memory address to be read from.

# + Summary

## Chapter 3

### A Top-Level View of Computer Function and Interconnection

- Computer components
- Computer function
  - Instruction fetch and execute
  - Interrupts
  - I/O function
- Interconnection structures
- Bus interconnection
  - Bus structure
  - Multiple bus hierarchies
  - Elements of bus design
- Point-to-point interconnect
  - QPI physical layer
  - QPI link layer
  - QPI routing layer
  - QPI protocol layer
- PCI express
  - PCI physical and logical architecture
  - PCIe physical layer
  - PCIe transaction layer
  - PCIe data link layer

Chapter 3 summary.